

cornici per porte - doors frames - encadrement pour portes - aros para portas

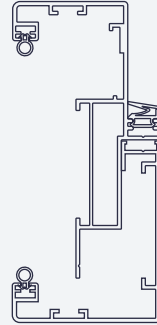

**CERCOS**  
para puertas





**Square 60**

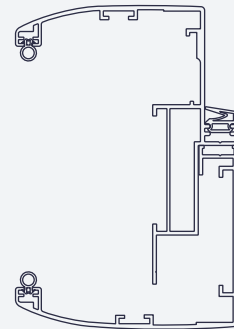

**Wave 90**

## SQUARE 60

Square 60 con un diseño racionalista, se presenta como una única superficie de líneas rectas, inspirando solidez y funcionalidad. Compuesto por un conjunto de perfiles que nos permitirán crear los diferentes tipos de puerta que necesitamos, desde el cerco con un fijo en la parte superior o bien con fijos en ambos laterales y otro en la parte superior, pudiendo ser estos fijos realizados en madera como máximo 25 mm de espesor o cristal desde un espesor de 6 mm hasta Unidades de Vidrio Aislante (UVA) de 4/12/4mm. Posibilidad de combinar los dos tipos de cercos Square 60 y Wave 90.

Square 60 con un disegno minimalista, si presenta come un'unica superficie lineare, ispirando solidità e funzionalità. Composto da giunzioni di profili, lo Square 60 permette realizzare differenti tipi di porte, consente anche il montaggio di pareti fisse sia di legno fino a 25mm sia di vetro da 6mm che di vetro isolante (UVA) da 4/12/4mm. Queste pareti fisse possono essere posizionate sia lateralmente che superiormente alle porte. Possibilità di combinare due tipi di cornici Square 60 e Wave 90.

Square 60 is a rationalist design, a single surface with straight lines that evoke both solidity and functionality. A set of profiles allows us to create the type of door we need, from a door with one fixed panel above, through to doors with fixed panels on both sides and above. These fixed panels can be made from timber up to 25mm thick, or glass from 6mm single to 4/12/4 double glazing units. Square 60 frames can be combined with Wave 90 frames.

Square 60 avec un design rationaliste, se présente comme une surface unique à lignes droites, qui inspire solidité et fonctionnalité. Composé par un ensemble de profils qui permettent de créer les types différents de portes dont nous avons besoin, depuis l'encadrement avec un profil fixe sur la partie supérieure jusqu'à la porte avec deux profils fixes sur les latéraux et un troisième sur la partie supérieure. Ces profils fixes peuvent être réalisés en bois jusqu'à 25 mm d'épaisseur ou en verre à partir de 6 mm et même en Unités de Vitrage Isolant de 4/12/4mm. Possibilité de combiner les deux types d'encadrements Square 60 et Wave 90.

Square 60 com um desenho racionalista, apresenta-se como uma superfície única de linhas rectas, inspirando solidez e funcionalidade. Composto por um conjunto de perfis que nos irão permitir criar os diferentes tipos de porta de que necessitamos, desde o aro com um perfil fixo na parte superior, até à porta com perfis fixos em ambas as partes laterais e outro na parte superior, podendo ser estes perfis fixos realizados em madeira com uma espessura de até 25 mm ou em vidro com uma espessura de 6 mm até Unidades de Vidro Isolante (UVI) de 4/12/4 mm. Possibilidade de combinar os dois tipos de aros Square 60 e Wave 90.

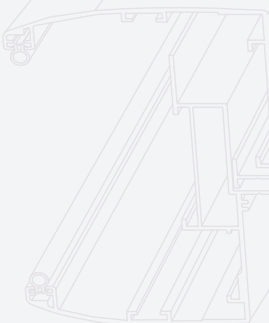



## Datos técnicos - Square 60

dati tecnici - technical details - données techniques - dados técnicos

Cerco compuesto por 2 piezas telescópicas con 30 mm de regulación, pudiendo realizar montajes en muros de entre 86 hasta 236 mm mediante el uso de los perfiles de ampliación existentes.

- Sencilla unión de los perfiles por medio de 3 escuadras.
- Disponible con bisagra de pernio o bisagra oculta.
- Posibilidad de instalar con sistema de cierre suave.
- Embalaje individual con junquillos premontados.
- Los perfiles incluyen film protector.
- Tres tipos de acabado: aluminio, lacado blanco y lacado negro.

Cornice composta da 2 profili telescopici con 30mm di regolazione, potendo realizzare montaggi su muri da 86mm fino a 236mm.

- Semplice unione dei profili per mezzo di 3 squadre.
- Disponibile montaggio con cerniera a perno o cerniera occulta.
- Possibilità di installare sistema di chiusura soft.
- Imballaggio singolo con guarnizioni premontate.
- I profili includono pellicola protettiva per superfici a vista.
- Tre tipi di finiture: alluminio anodizzato, laccato bianco e laccato nero.

The frame is made of 2 telescopic pieces, adjustable up to 30mm. They can be installed in walls from 86mm to 236mm, using the extension profiles.

- Simple profile joints with 3 brackets.
- Available with barrel hinges or hidden hinges.
- Can be installed with soft-close system.
- Individually packaged with pre-mounted moulding.
- Profiles come with protective film.
- Three finishes: aluminium, white paint and black paint.

Encadrement composé par 2 pièces télescopiques de 30 mm de réglage, qui permet de faire des montages sur les murs de 86 à 236 mm grâce aux profils d'élargissement existants.

- Union simple des profils au moyen de 3 équerres.
- Disponible avec charnière à cylindre ou charnière de peinture.
- Possibilité d'installation avec système de fermeture douce de porte.
- Emballage individuel avec les jonquilles prémontées.
- Les profils comprennent un film protecteur.
- Trois sortes de finition: en aluminium, laqué blanc et laqué noir.

Aro composto por 2 peças telescópicas com 30 mm de regulação, sendo possível a montagem em paredes de 86 a 236 mm através da utilização dos perfis de ampliação existentes.

- Fácil união dos perfis através de 3 esquadros.
- Disponível com dobradiça de balanço ou dobradiça oculta.
- Possibilidade de instalação com sistema de fecho de porta suave.
- Embalagem individual com linguetas pré-montadas.
- Os perfis incluem película protectora.
- Três tipos de acabamento: alumínio, lacado branco e lacado preto.

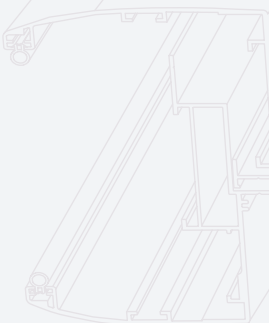

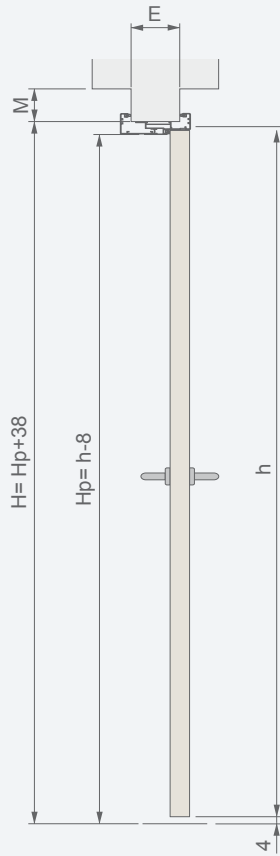
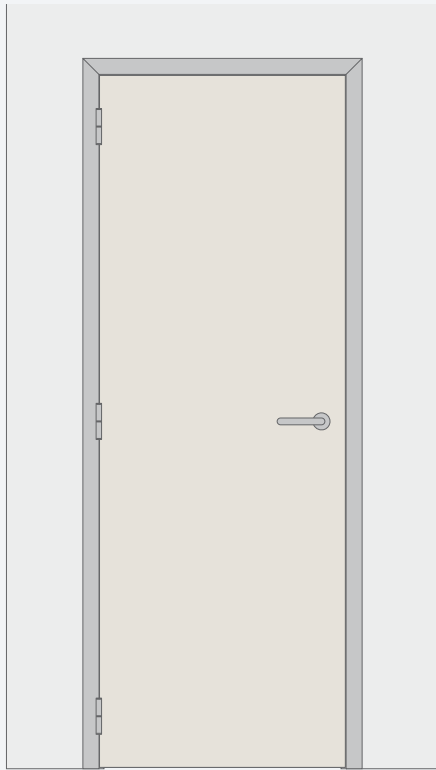

M= min. 60mm  
E= 86 min. 236 max.

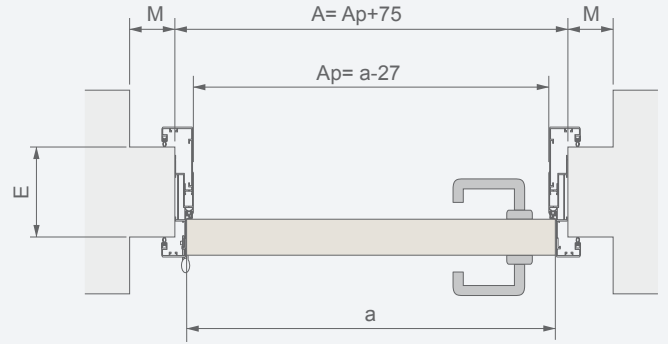

$a = Ap + 27$      $a = A - 48$      $A = a + 48$   
 $h = Hp + 8$      $h = H - 30$      $H = h + 30$

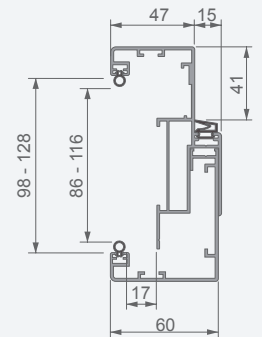
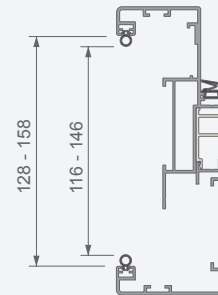
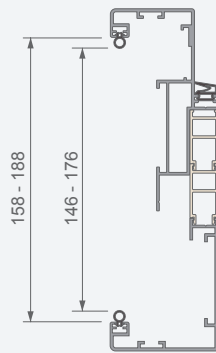
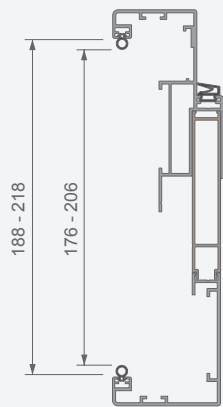
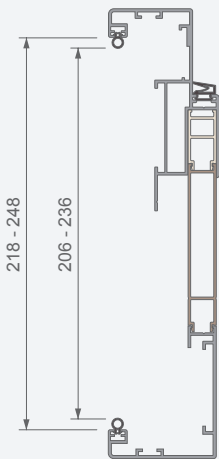
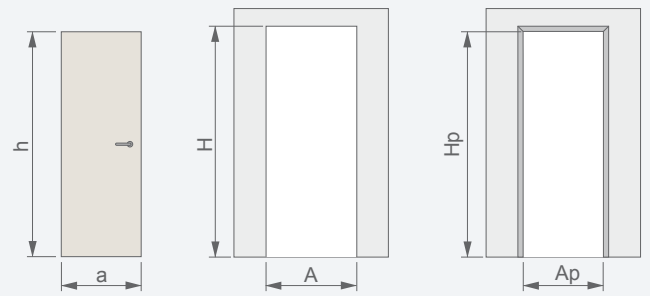

## Wave 90

Wave 90 con una estética basada en la naturaleza, sus formas suavemente redondeadas nos dan calidez y elegancia.

El Wave 90 se completa con un conjunto de perfiles que nos permitirán crear los diferentes tipos de puerta que necesitamos, comenzando con el cerco para puerta de paso convencional o bien con fijos laterales y superiores, pudiendo ser estos fijos realizados en madera como máximo 25mm o cristal desde un espesor de 6 mm hasta Unidades de Vidrio Aislante (UVA) de 4/12/4mm.

Wave 90 presenta un'estetica basata nella naturalezza, la sua forma stondata trasmette calore ed eleganza.

Composto da giunzioni di profili, il Wave 90 permette realizzare differenti tipi di porte, consente anche il montaggio di pareti fisse sia di legno fino a 25mm sia di vetro da 6mm che di vetro isolante (UVA) da 4/12/4mm. Queste pareti fisse possono essere posizionate sia lateralmente che superiormente alle porte.

Possibilità di combinare due tipi di cornici Square 60 e Wave 90.

The look of Wave 90 is based on nature, with its softly rounded forms providing warmth and elegance.

Wave 90 has a set of profiles that allow us to create the type of door we need, from a conventional doorway through to doors with fixed side and upper panels. These fixed panels can be made from timber up to 25mm thick, or glass from 6mm single to 4/12/4 double glazing units.

Wave 90 avec une esthétique qui se base sur la nature, ses formes doucement arrondies nous donnent de la chaleur et de la beauté.

Le Wave 90 se complète avec un ensemble de profils qui nous permettent de créer les différents types de portes dont nous avons besoin, en commençant par l'encadrement pour porte de passage conventionnel, jusqu'à la porte avec des profils fixes latéraux et supérieurs en bois jusqu'à 25 mm ou en verre à partir de 6mm d'épaisseur, ou même en Unités de Vitrage Isolant de 4/12/4mm.

Wave 90, com uma estética baseada na natureza, as suas formas suavemente arredondadas dão-nos calor e elegância.

O Wave 90 completa-se com um conjunto de perfis que nos irão permitir criar os diferentes tipos de porta de que necessitamos, começando com o aro para porta de passagem convencional, até à porta com perfis fixos laterais e superiores, podendo ser estes perfis fixos realizados em madeira com uma espessura de até 25 mm ou em vidro com uma espessura de 6 mm até Unidades de Vidro Isolante (UVI) de 4/12/4mm.

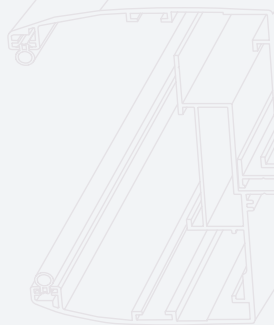



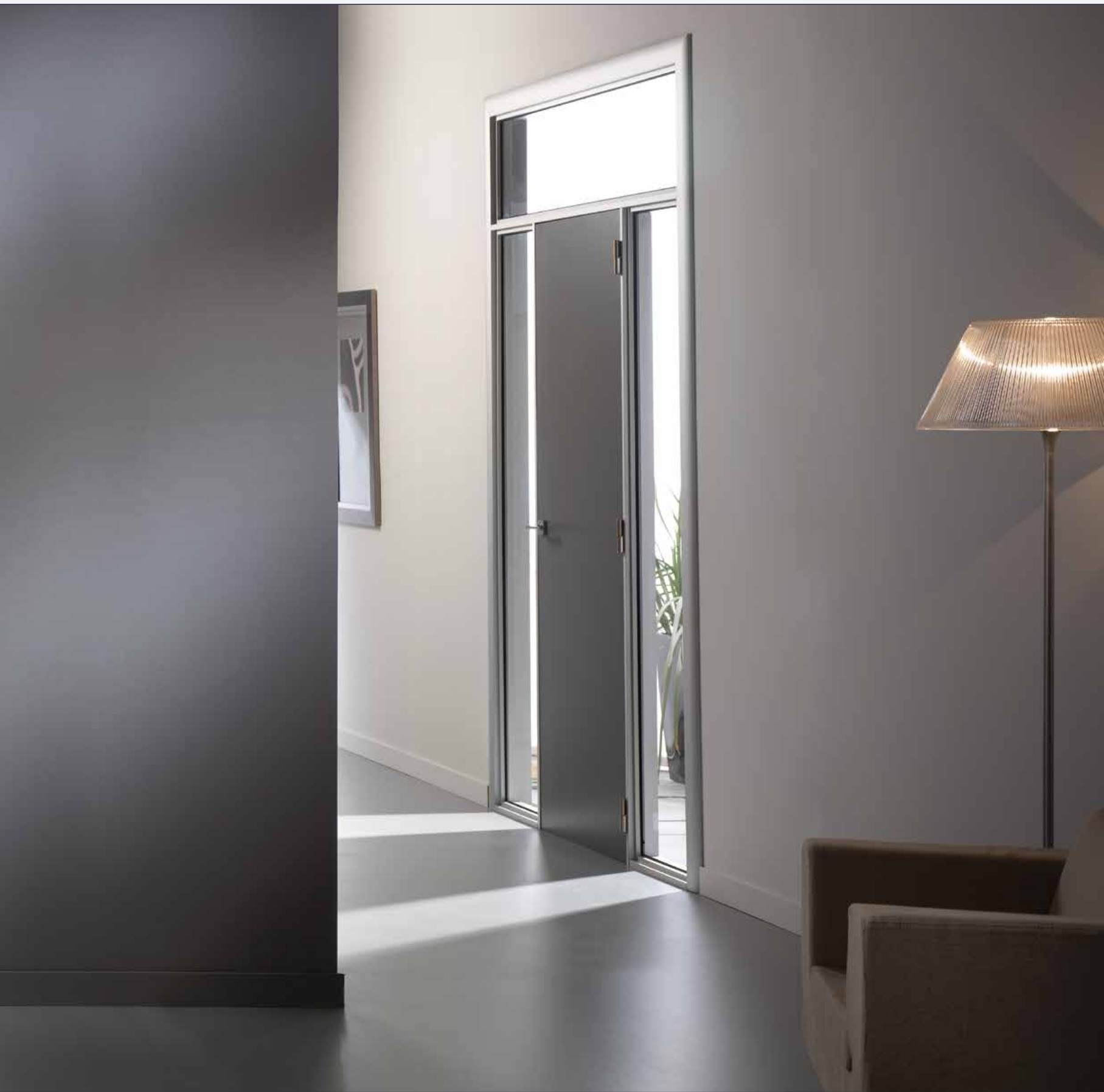

## Datos técnicos - Wave 90

dati tecnici - technical details - données techniques - dados técnicos

Cerco compuesto por 2 piezas telescópicas con 30 mm de regulación, pudiendo realizar montajes en muros de entre 86 hasta 236 mm mediante el uso de los perfiles de ampliación existentes.

- Sencilla unión de los perfiles por medio de 3 escuadras.
- Disponible con bisagra de pernio o bisagra oculta.
- Posibilidad de instalar con sistema de cierre suave.
- Embalaje individual con junquillos premontados.
- Los perfiles incluyen film protector.
- Tres tipos de acabado: aluminio, lacado blanco y lacado negro.

Cornice composta da 2 profili telescopici con 30mm di regolazione, potendo realizzare montaggi su muri da 86mm fino a 236mm.

- Semplice unione dei profili per mezzo di 3 squadre.
- Disponibile montaggio con cerniera a perno o cerniera occulta.
- Possibilità di installare sistema di chiusura soft.
- Imballaggio singolo con guarnizioni premontate.
- I profili includono pellicola protettiva per superfici a vista.
- Tre tipi di finiture: alluminio anodizzato, laccato bianco e laccato nero.

The frame is made of 2 telescopic pieces, adjustable up to 30mm. They can be installed in walls from 86mm to 236mm, using the extension profiles.

- Simple profile joints with 3 brackets.
- Available with barrel hinges or hidden hinges.
- Can be installed with soft-close system.
- Individually packaged with pre-mounted moulding.
- Profiles come with protective film.
- Three finishes: aluminium, white paint and black paint.

Encadrement composé par 2 pièces télescopiques de 30 mm de réglage, qui permet de faire des montages sur les murs de 86 à 236 mm grâce aux profils d'élargissement existants.

- Union simple des profils au moyen de 3 équerres.
- Disponible avec charnière à cylindre ou charnière de peinture.
- Possibilité d'installation avec système de fermeture douce de porte.
- Emballage individuel avec les jonquilles prémontées.
- Les profils comprennent un film protecteur.
- Trois sortes de finition: en aluminium, laqué blanc et laqué noir.

Aro composto por 2 peças telescópicas com 30 mm de regulação, sendo possível a montagem em paredes de 86 a 236 mm através da utilização dos perfis de ampliação existentes.

- Fácil união dos perfis através de 3 esquadros.
- Disponível com dobradiça de balanço ou dobradiça oculta.
- Possibilidade de instalação com sistema de fecho de porta suave.
- Embalagem individual com linguetas pré-montadas.
- Os perfis incluem película protectora.
- Três tipos de acabamento: alumínio, lacado branco e lacado preto.

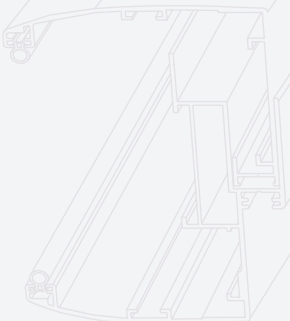

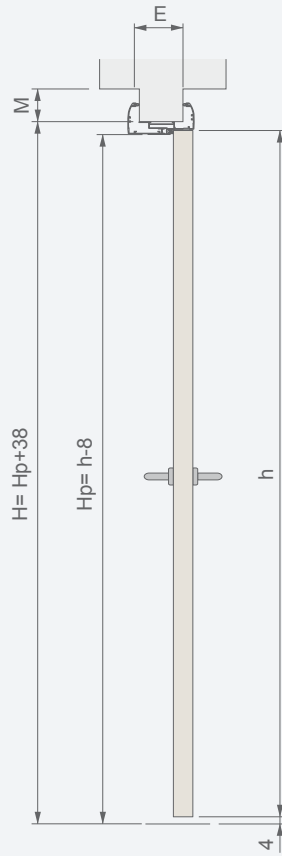
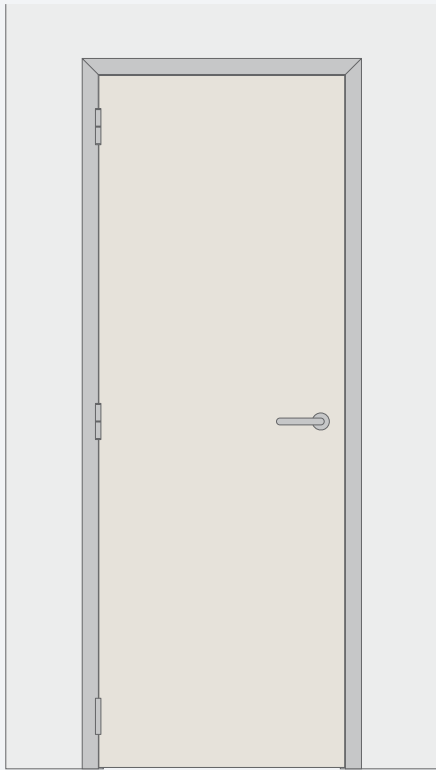

M= min. 60mm  
E= 86 min. 236 max.

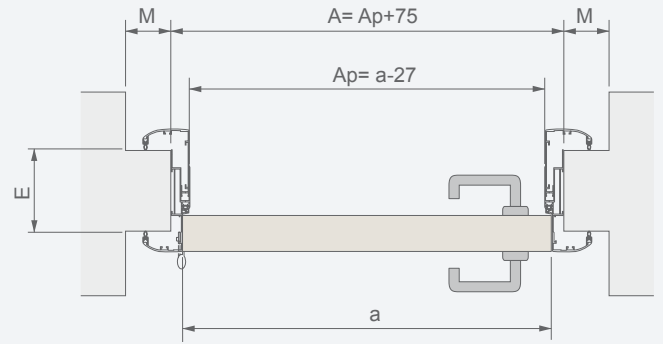

$a = Ap + 27$      $a = A - 48$      $A = a + 48$   
 $h = Hp + 8$      $h = H - 30$      $H = h + 30$

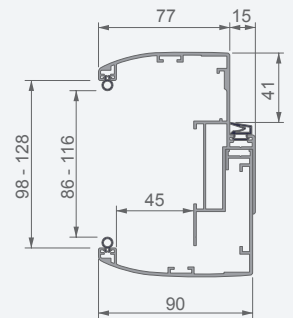
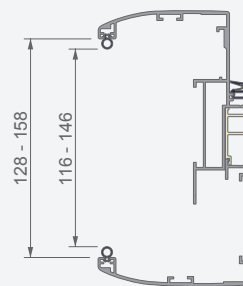
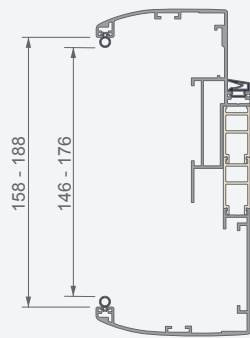
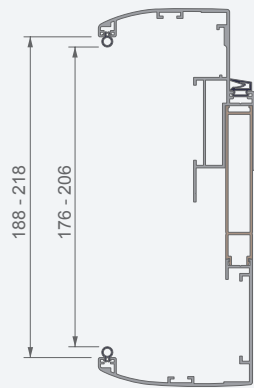
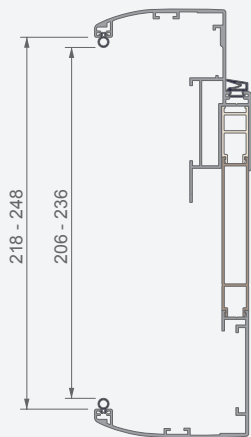
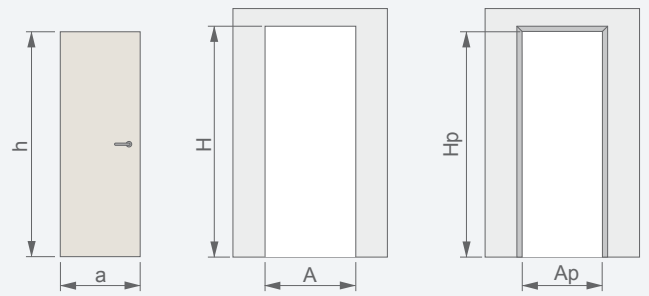

## Tipos de cercos

tipi di cornici - types of frames

types de encandrement - tipos de aros

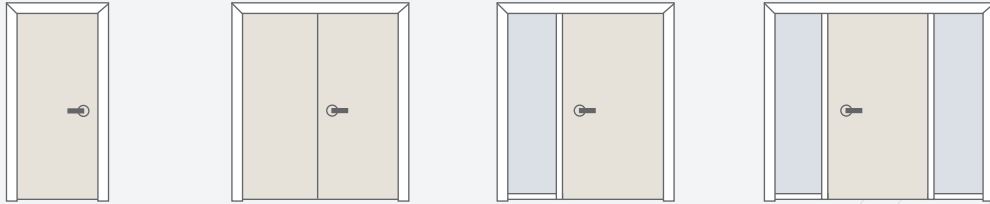

Puertas de paso  
porte passaggio - passage doors  
portes de passage - portas de passagem

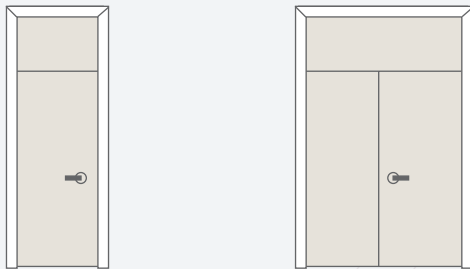

Con travesaño oculto  
con traverso nascosto - with hidden crossbar  
avec traverse invisible - com travessa oculta

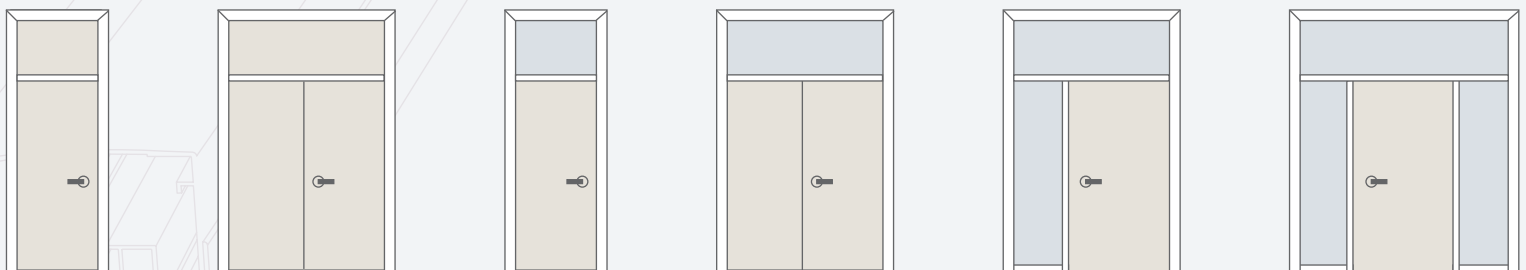

Con travesaño visto  
con traverso a vista - with visible crossbar  
avec traverse visible - com travessa visível

CERCO HASTA TECHO - CORNICE FINO AL SOFFITTO - FRAME TO THE TOP - ENCANDREMENT JUSQU'AU PLAFOND - COM MOLDURA ATÉ AO TECTO



Con travesaño oculto  
con traveso nascosto - with hidden crossbar  
avec traverse invisible - com travessa oculta



Con travesaño visto  
con traveso a vista - with visible crossbar  
avec traverse visible - com travessa visível

CERCOS ESPECIALES - CORNICI SPECIALI - SPECIAL FRAME - ENCANDREMENT SPÉCIALES - AROS ESPECIAIS

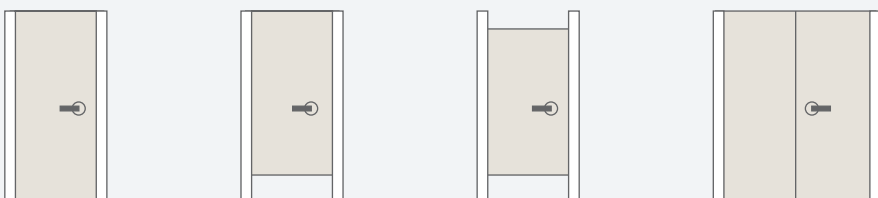

Especiales  
speciali - special  
spéciales - especiais

## Gama de acabados

gamma di finiture - range of finishings  
gamme de finitions - gama de acabamentos



Aluminio  
alluminio - aluminium  
aluminium - alumínio



Lacado blanco  
laccato bianco - white laqué  
blanc laquée - lacado branco



Lacado negro  
laccato nero - black laqué  
noir laquée - lacado preto

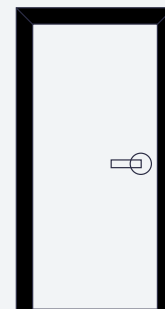
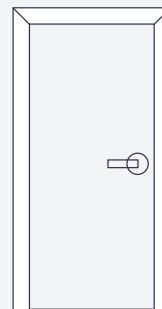
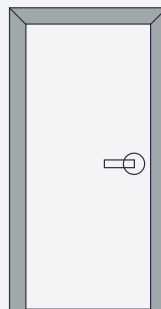

## Accesorios

accessori - accessories  
accessoires - acessórios



Bisagra oculta apertura 180°  
cerniera a scomparsa - hidden hinge - charnière invisible - dobradiça oculta

Bisagra de perno  
cerniera a perno - barrel hinge - charnière à cylindre - dobradiça de balanço

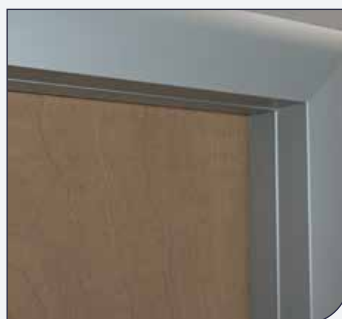

Cierre suave  
chiusura soft - soft-close - fermeture douce - fecho suave

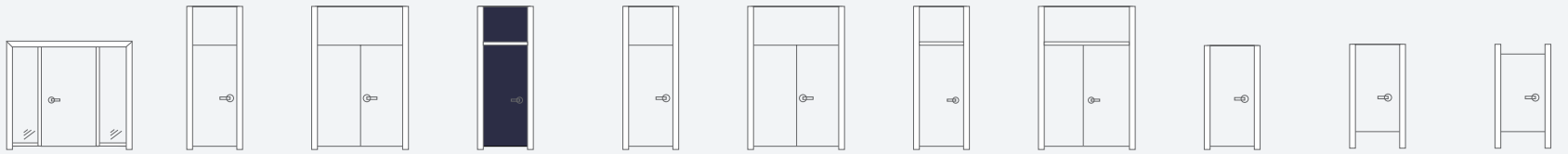
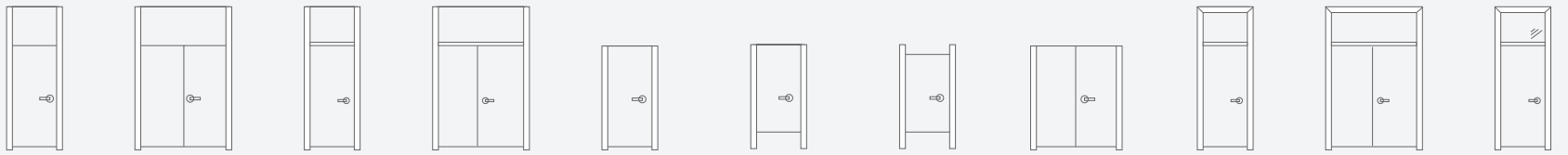
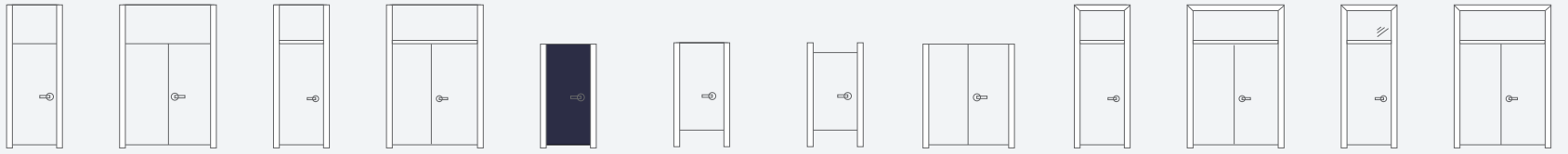



Fenólicos  
del Sur+

**Fenólicos del Sur**

Polígono San Nicolás C/ San Nicolás Uno, Nave 18  
41500 Alcalá de Guadaira • Sevilla

Tfl. 955 753 130 • 657 964 818

mangel@fenolicosdelsur.es • [www.fenolicosdelsur.es](http://www.fenolicosdelsur.es)